

Face milling cutters

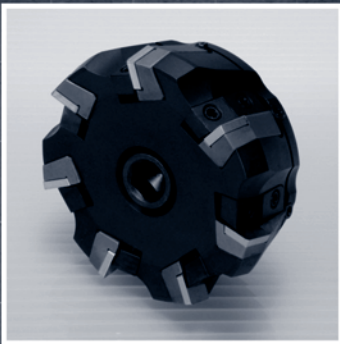
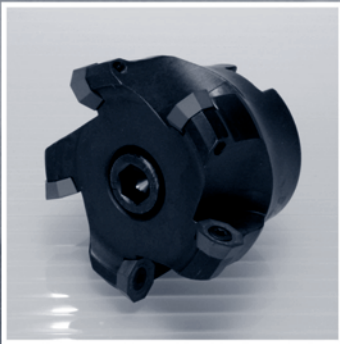

Face milling cutters

Code Key	B.02
Technical information	B.04
Applications	B.05
Face milling cutters	B.06
Cutting data	B.37

Face milling cutters

Square shoulder cutters

Slot cutters

Porcupine cutters

Specific applications and sets

Profile milling

Solid carbide

Drills

Boring heads

Arbors and adaptors

Inserts

Face milling cutters

1	
01	02
03	04
05	06
07	08
09	11
12	13
14	15
16	17
18	19
22	23
25	29
30	33
35	55
85	88
89	96

0 4

2	
1	
2	
3	
4	
5	
6	
8	
9	
1	
2	
3	
4	
5	
6	
8	
9	

4

3	
0	
2	
4	
5	
6	
7	
8	
9	

0

4	
Short cylindric Ø16 Ø20 Ø25 00	Long cylindric Ø20 Ø25 Ø32 Ø20 Ø25 Ø32 01 02
Short cylindric Ø16 Ø20 Ø25 03	Modular shank Ø46 M27 06
Short Weldon Ø12 Ø16 Ø20 Ø25 Ø32 Ø40 07 21	Long Weldon Ø12 Ø16 Ø20 Ø25 Ø32 Ø40 27
Short Morse M2-M3 M4 M5 30 34 35	Long Morse M3 M4 32 36
ISO ISO 30 ISO 40 ISO 50 43 44 45	DIN 2080 ISO 7388 DIN 69871 A 7388 40 7388 50 47 48
ISO BT 40 BT 50 49 50	BT System R-8 Bridgeport shank R-8 80
Direct spindle mounting 90	Direct spindle mounting 93
Direct spindle mounting 95	Cutting hand 96
Direct spindle mounting 99	

Diameter, mm.
 Ø
 Ø

Coarse pitch	Fine pitch	Cutting hand
 0	 1	 R L
*		

Cutting length	Cutting width	Cutting depth
 a	 	

99

125

1
24

*
**

- Face milling cutters
- Square shoulder cutters
- Slot cutters
- Porcupine cutters
- Specific applications and sets
- Profile milling
- Solid carbide
- Drills
- Boring heads
- Arbors and adaptors

Inserts

Face milling cutters

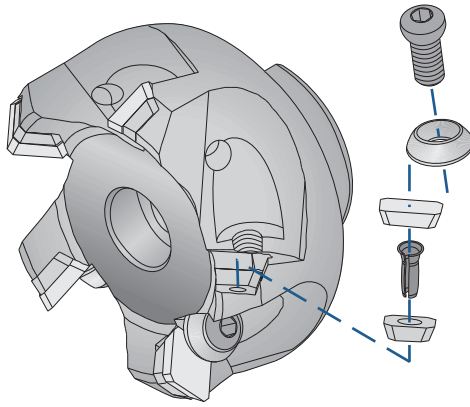

C Clamp

This classic positive insert clamping system allows the use of all models presenting this geometry, both with additional chipbreaker and sintered.

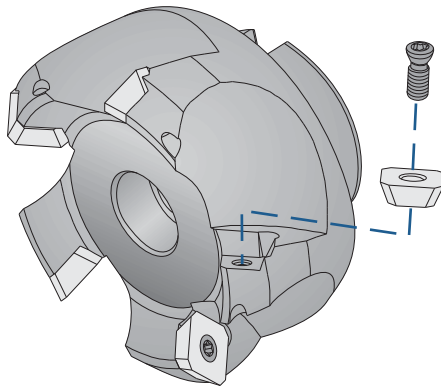

Screw clamping

Since the advent of the Torx screw it has been possible to hold with complete safety positive inserts with centre hole. Our range covers all the screw clamping permutations.

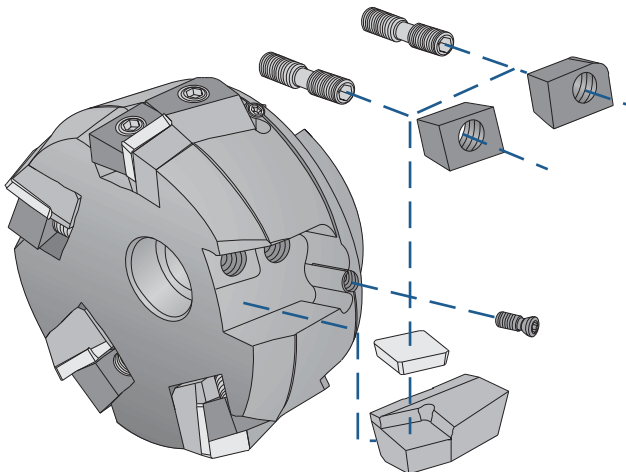

Wedge clamping



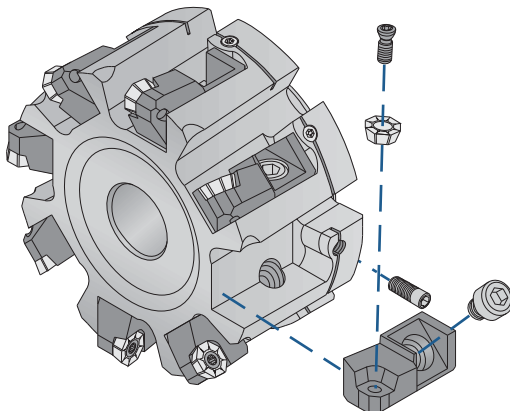























Heavy duty work require good fixation, for this purpose we have designed our wedge clamping system, one of the safest available.



Cartridge system

Cartridge system for heavy duty work with positive center hole inserts. The axial regulation screw allows a perfect adjustment for super-finishing applications.

Face milling cutters

<p>0440.90 75° General application 75°</p>  <p>Page B.06 SP.. 1203..</p>	<p>0440.99 75° General application 75°</p>  <p>Page B.07 SP.. 1203..</p>	<p>0450.99 75° Deep cutting 75°</p>  <p>Page B.08 SP.. 1504..</p>	<p>0442.90 75° Casting applications 75°</p>  <p>Page B.10 SN.. 1204..</p>	<p>0442.99 75° Casting applications 75°</p>  <p>Page B.11 SN.. 1204..</p>	<p>0630.00 Chamfering 45°</p>  <p>Page B.12 TPUN 1603..</p>
<p>0630.07 Chamfering 45°</p>  <p>Page B.13 TPUN 1603..</p>	<p>0630.30 Chamfering 45°</p>  <p>Page B.14 TPUN 1603..</p>	<p>0630.90 45° Facing and chamfering 45°</p>  <p>Page B.15 TPUN 1603..</p>	<p>0640.90 45° Facing and chamfering 45°</p>  <p>Page B.16 TPUN 2204..</p>	<p>0740.00 Chamfering 45°</p>  <p>Page B.18 SPM.. 1204..</p>	<p>0740.07 Chamfering 45°</p>  <p>Page B.19 SPM.. 1204..</p>
<p>0740.30 Chamfering 45°</p>  <p>Page B.20 SPM.. 1204..</p>	<p>0744.90 45° Facing and chamfering 45°</p>  <p>Page B.21 SC.. 1204..</p>	<p>0748.90 45° First choice 45°</p>  <p>Page B.22 SEK.. 1203..</p>	<p>0748.99 45° General application 45°</p>  <p>Page B.23 SEK.. 1203..</p>	<p>0758.99 45° Deep cutting 45°</p>  <p>Page B.24 SEKN 1504..</p>	<p>1430.90 75° General application 75°</p>  <p>Page B.26 APKT 1604..</p>
<p>1748.07 Facing and chamfering 45°</p>  <p>Page B.28 SEH.. 1204..</p>	<p>1748.90 45° Soft materials 45°</p>  <p>Page B.29 SEH.. 1204..</p>	<p>1748.93 45° Soft materials 45°</p>  <p>Page B.30 SEH.. 1204..</p>	<p>1748.99 45° Soft materials 45°</p>  <p>Page B.31 SEH.. 1204..</p>	<p>1845.90 42° Multipurpose milling 42°</p>  <p>Page B.32 ODMT 0404..</p>	<p>1845.99 42° Multipurpose milling 42°</p>  <p>Page B.33 ODM.. 0404..</p>
<p>1855.90 42° Multipurpose milling 42°</p>  <p>Page B.34 ODM.. 0605..</p>	<p>1855.99 42° Multipurpose milling 42°</p>  <p>Page B.35 ODM.. 0605..</p>				

- Face milling cutters
- Square shoulder cutters
- Slot cutters
- Porcupine cutters
- Specific applications and sets
- Profile milling
- Solid carbide
- Drills
- Boring heads
- Arbors and adaptors

Inserts

Face milling cutters

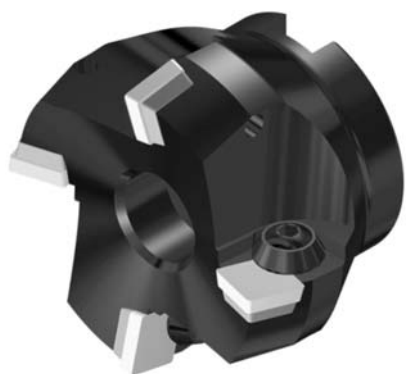

Characteristics:

Positive milling cutter with 75° entering angle. Its strong inserts accept high cutting depths and high feed per teeth. The original fixing system from Canela allows a quick insert assembly and dismantling. All milling cutters starting from diameter 50 are equipped with shim seats to protect the milling cutter body in case of accident.

Applications:

This face milling cutter works well on steels, stainless steel, alloyed steels, cast iron and aluminium alloys. This general purpose milling cutter is recommended for manual machines as well as for C.N.C. machines.

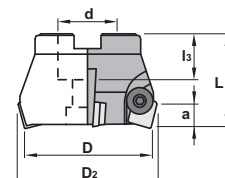
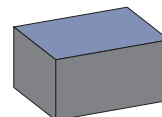
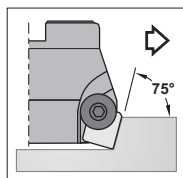

0440.90 75°

Ref.			D	D ₂	L	d	l ₃	a	Insert size	
0440.90.040	3		40	46	40	16	18	9	SP.. 1203..	0,250
0440.90.050	3		50	56	40	22	20	9	SP.. 1203..	0,300
0440.90.063	4		63	69	50	27	22	9	SP.. 1203..	0,700
0440.90.080	5		80	86	50	32	25	9	SP.. 1203..	1,100
0440.90.100	6		100	106	50	40	29	9	SP.. 1203..	1,800
0440.90.125	6		125	131	63	40	30	9	SP.. 1203..	3,500
0440.90.160	7		160	166	63	40	30	9	SP.. 1203..	5,600
0440.90.200	8		200	206	63	60	40	9	SP.. 1203..	9,150

Ref.						
0440.90.040	1006	5004	2066	-	-	1058
0440.90.050	1006	5004	2066	3012	4012	912,10
0440.90.063	1006	5004	2066	3012	4012	912,12
0440.90.080	1006	5004	2066	3012	4012	912,17
0440.90.100	1006	5004	2066	3012	4012	912,20
0440.90.125	1006	5004	2066	3012	4012	-
0440.90.160	1006	5004	2066	3012	4012	912,52
0440.90.200	1006	5004	2066	3012	4012	912,56

Ref.	SP..	l	s	d	Positive 11° clearance - Square inserts.
	SP.. 1203..	12,70	3,18	12,70	
	SPKN	SPKR	SPUN		

For more information see page: A.19



Characteristics:

Positive milling cutter with 75° entering angle. Its strong inserts accept high cutting depths and high feed per teeth. The fixing system by wedge ensures an excellent fixation of the insert and a higher security on difficult conditions. The indexable cartridges protect the milling cutter body in case of accident.

Applications:

This face milling cutter works well on steels, stainless steel, alloyed steels, cast iron and aluminium alloys. This general purpose milling cutter is recommended for manual machines as well as for C.N.C. machines. It is a good choice for economical machining since the SPUN type insert can be fitted.

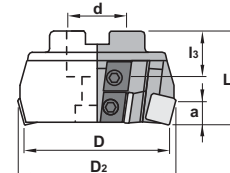
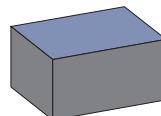
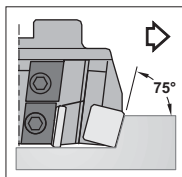

0440.99 75°

Ref.			D	D ₂	L	d	l ₃	a	Insert size	
0440.99.080	5		80	86	50	27	22	9	SP.. 1203..	1,250
0440.99.100	7		100	106	50	32	25	9	SP.. 1203..	2,000
0440.99.125	8		125	131	63	40	30	9	SP.. 1203..	3,500
0440.99.160	10		160	166	63	40	30	9	SP.. 1203..	5,750
0440.99.200	12		200	206	63	60	40	9	SP.. 1203..	9,000
0440.99.250	16		250	256	63	60	40	9	SP.. 1203..	14,200
0440.99.315	20		315	321	63	60	40	9	SP.. 1203..	31,000
0440.99.400	26		400	406	63	60	40	9	SP.. 1203..	47,500
0440.99.500	34		500	506	63	60	40	9	SP.. 1203..	85,000

Ref.									
0440.99.080	1077	5620	6437	6438	6914	1460	912,12	-	-
0440.99.100	1077	5620	6437	6438	6914	1460	912,20	-	-
0440.99.125	1077	5620	6437	6438	6914	1460	-	-	-
0440.99.160	1077	5620	6437	6438	6914	1460	912,52	40	40
0440.99.200	1077	5620	6437	6438	6914	1460	912,56	50	50
0440.99.250	1077	5620	6437	6438	6914	1460	912,56	50	50
0440.99.315	1077	5620	6437	6438	6914	1460	912,56	50/60	50/60
0440.99.400	1077	5620	6437	6438	6914	1460	912,56	50/60	50/60
0440.99.500	1077	5620	6437	6438	6914	1460	912,56	50/60	50/60

Ref.	SP..			Positive 11° clearance - Square inserts.
	l	s	d	
SP.. 1203..	12,70	3,18	12,70	
	SPKN	SPKR	SPUN	

For more information see page: A.19

- Face milling cutters
- Square shoulder cutters
- Slot cutters
- Porcupine cutters
- Specific applications and sets
- Profile milling
- Solid carbide
- Drills
- Boring heads
- Arbors and adaptors

Inserts

Face milling cutters



Characteristics:

Positive milling cutter with 75° entering angle. Its strong inserts accept high cutting depths and high feed per teeth. The fixing system by wedge ensures an excellent fixation of the insert and a higher security on difficult conditions. The indexable cartridges protect the milling cutter body in case of accident.

Applications:

This face milling cutter works well on steels, stainless steel, alloyed steels, cast iron and aluminium alloys. This general purpose milling cutter is recommended for manual machines as well as for C.N.C. machines. It is a good choice for economical machining since the SPUN type insert can be fitted.

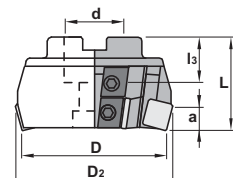
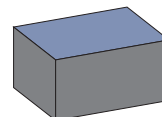
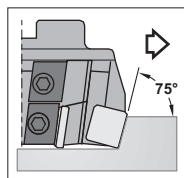

0450.99 75°

Ref.		D	D ₂	L	d	l ₃	a	Insert size	
0450.99.100	7	100	108	50	32	25	12	SP.. 1504..	1,950
0450.99.125	8	125	133	63	40	30	12	SP.. 1504..	3,500
0450.99.160	10	160	168	63	40	30	12	SP.. 1504..	5,450
0450.99.200	12	200	208	63	60	40	12	SP.. 1504..	8,950
0450.99.250	16	250	258	63	60	40	12	SP.. 1504..	14,200
0450.99.315	20	315	323	63	60	40	12	SP.. 1504..	31,000
0450.99.400	26	400	408	63	60	40	12	SP.. 1504..	47,500
0450.99.500	34	500	508	63	60	40	12	SP.. 1504..	85,000

Ref.									
0450.99.100	1077	5620	6439	6440	6915	1460	912,17	-	-
0450.99.125	1077	5620	6439	6440	6915	1460	-	-	-
0450.99.160	1077	5620	6439	6440	6915	1460	912,52	40	40
0450.99.200	1077	5620	6439	6440	6915	1460	912,56	50	50
0450.99.250	1077	5620	6439	6440	6915	1460	912,56	50	50
0450.99.315	1077	5620	6439	6440	6915	1460	912,56	50/60	50/60
0450.99.400	1077	5620	6439	6440	6915	1460	912,56	50/60	50/60
0450.99.500	1077	5620	6439	6440	6915	1460	912,56	50/60	50/60

SP..		l	s	d	Positive 11° clearance - Square inserts.
Ref.	SP.. 1504..	15,88	4,76	15,88	
For more information see page: A.19					
SPKN	SPUN				

0440 / 0450

Positive milling cutter with 75° entering angle. Its strong inserts accept high cutting depths and high feed per teeth.

The fixing system by wedge ensures an excellent fixation of the insert and a higher security on difficult conditions. The indexable cartridges protect the milling cutter body in case of accident.

This face milling cutter works well on steels, stainless steel, alloyed steels, cast iron and aluminium alloys.

This general purpose milling cutter is recommended for manual machines as well as for C.N.C. machines.

It is good choice for economical machining since the SPUN type insert can be fitted.

The axial regulation screw allows a perfect adjustment for super-finishing applications.

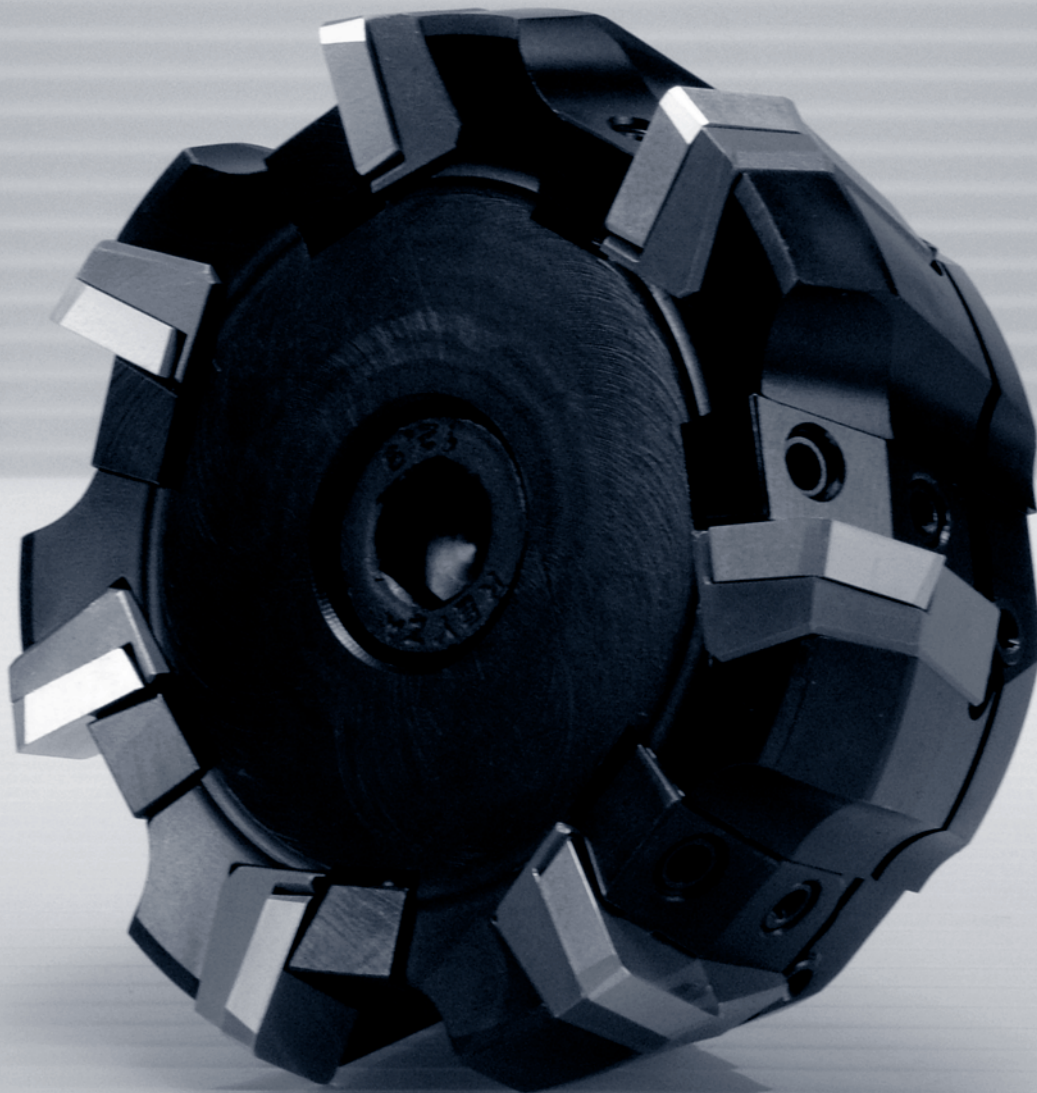

Face milling cutters

Square shoulder cutters

Slot cutters

Porcupine cutters

Specific applications and sets

Profile milling

Solid carbide

Drills

Boring heads

Arbors and adaptors

Inserts

Face milling cutters

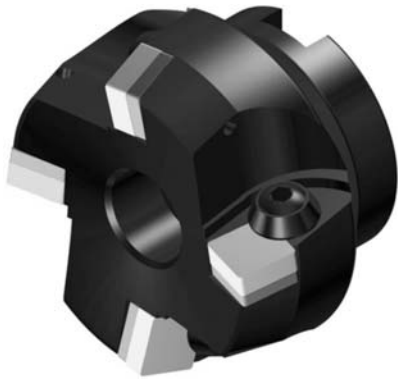

Characteristics:

Negative milling cutter with 75° entering angle. Its strong inserts accept high cutting depths and high feed per teeth. The original fixing system from Canela allows a quick insert assembly and dismantling. All milling cutters starting from diameter diameter 50 are equipped with shim seats to protect the milling cutter body in case of accident.

Applications:

This face milling cutter works well on steels, alloyed steels and is the first option for cast iron. This general purpose milling cutter is recommended for manual machines as well as for C.N.C. machines. It is a good choice for economical machining since the SPUN type insert can be fitted.

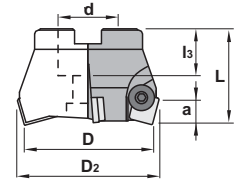
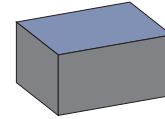
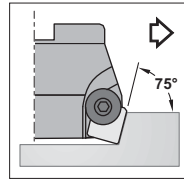

0442.90 75°

Ref.			D	D2	L	d	l3	a	Insert size	
0442.90.050	3	50	56	40	22	20	9	SN.. 1204..	0,380	
0442.90.063	4	63	69	50	27	22	9	SN.. 1204..	0,750	
0442.90.080	5	80	86	50	32	25	9	SN.. 1204..	1,250	
0442.90.100	6	100	106	50	40	29	9	SN.. 1204..	2,000	

Ref.						
0442.90.050	1006	5004	2066	3212	4012	912,10
0442.90.063	1006	5004	2066	3212	4012	912,12
0442.90.080	1006	5004	2066	3212	4012	912,17
0442.90.100	1006	5004	2066	3212	4012	912,20

Ref.	SN..	l	s	d	Negative square inserts
	SN.. 1204..	12,70	4,76	12,70	
	SNKN	SNUN			

For more information see page: A.18



Characteristics:

Negative milling cutter with 75° entering angle. Its strong inserts accept high cutting depths and high feed per teeth. The fixing system by wedge ensures an excellent fixation of the insert and a higher security on difficult aconditions. The indexable cartridges protect the milling cutter body in case of accident.

Applications:

This face milling cutter works well on steels, alloyed steels and is the first option for cast iron. This general purpose milling cutter is recommended for manual machines as well as for C.N.C. machines. It is a good choice for economical machining since the SPUN type insert can be fitted.

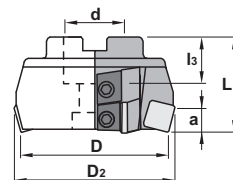
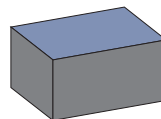
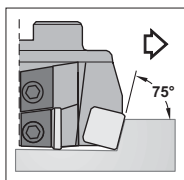

0442.99 75°

Ref.			D	D ₂	L	d	l ₃	a	Insert size	
0442.99.080	5		80	86	50	27	22	9	SN.. 1204..	1,200
0442.99.100	7		100	106	50	32	25	9	SN.. 1204..	1,950
0442.99.125	8		125	131	63	40	30	9	SN.. 1204..	3,250
0442.99.160	10		160	166	63	40	30	9	SN.. 1204..	5,650
0442.99.200	12		200	206	63	60	40	9	SN.. 1204..	8,600
0442.99.250	16		250	256	63	60	40	9	SN.. 1204..	14,000
0442.99.315	20		315	321	63	60	40	9	SN.. 1204..	31,000
0442.99.400	26		400	406	63	60	40	9	SN.. 1204..	47,500
0442.99.500	34		500	506	63	60	40	9	SN.. 1204..	85,000

Ref.									
0442.99.080	1077	5620	6432	6438	6912	1460	912,12	-	-
0442.99.100	1077	5620	6432	6438	6912	1460	912,17	-	-
0442.99.125	1077	5620	6432	6438	6912	1460	-	-	-
0442.99.160	1077	5620	6432	6438	6912	1460	912,52	40	
0442.99.200	1077	5620	6432	6438	6912	1460	912,56	50	
0442.99.250	1077	5620	6432	6438	6912	1460	912,56	50	
0442.99.315	1077	5620	6432	6438	6912	1460	912,56	50/60	
0442.99.400	1077	5620	6432	6438	6912	1460	912,56	50/60	
0442.99.500	1077	5620	6432	6438	6912	1460	912,56	50/60	

Ref.	SN..	l	s	d	Negative square inserts
	SN.. 1204..	12,70	4,76	12,70	
	SNKN				
	SNUN				

For more information see page: A.18

Face milling cutters

Square shoulder cutters

Slot cutters

Porcupine cutters

Specific applications and sets

Profile milling

Solid carbide

Drills

Boring heads

Arbors and adaptors

Inserts

Face milling cutters



Characteristics:

Positive milling cutter with 45° entering angle. Its strong inserts accept high cutting depths and high feed per teeth. The original fixing system from Canela allows a quick insert assembly and dismantling. All milling cutters starting from diameter 5.

Applications:

This chamfer milling cutter works well on steels, stainless steel, alloyed steels, cast iron and aluminium alloys. This general purpose milling cutter is recommended for manual machines as well as for C.N.C. machines.

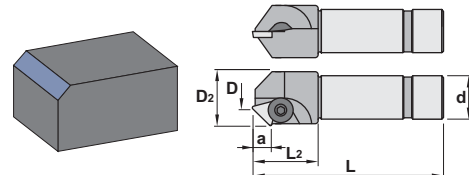
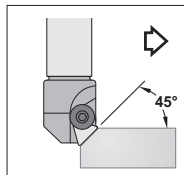

0630.00

Ref.			D	D2	L	L2	d	a	Insert size	
0630.00.005	1		6,5	26,5	110	35	20	8	TPUN 1603..	0,300
0630.00.020	3		20,0	40,0	125	35	25	8	TPUN 1603..	0,500

Ref.				
0630.00.005		1006	2064	5004
0630.00.020		1006	2064	5004

Ref.	TPUN 1603..	l	s	d	Positive 11° clearance - Triangular insert.
For more information see page: A.21					
	TPUN				

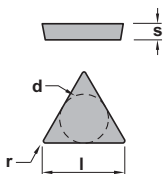



Characteristics:

Positive milling cutter with 45° entering angle. Its strong inserts accept high cutting depths and high feed per teeth. The original fixing system from Canela allows a quick insert assembly and dismantling. All milling cutters starting from diameter 5.

Applications:

This chamfer milling cutter works well on steels, stainless steel, alloyed steels, cast iron and aluminium alloys. This general purpose milling cutter is recommended for manual machines as well as for C.N.C. machines.

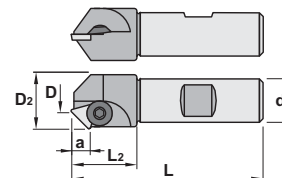
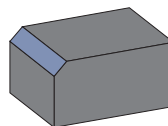
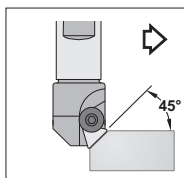

0630.07

Ref.		D	D2	L	L2	d	a	Insert size	
0630.07.005	1	6,5	26,5	110	35	25	8	TPUN 1603..	0,400
0630.07.020	3	20,0	40,0	110	35	25	8	TPUN 1603..	0,450

Ref.			
0630.07.005	1006	2064	5004
0630.07.020	1006	2064	5004

TPUN		l	s	d	Positive 11° clearance - Triangular insert.
Ref.	TPUN 1603..	16,50	3,18	9,52	
For more information see page: A.21					
TPUN					

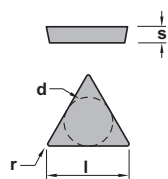

- Face milling cutters
- Square shoulder cutters
- Slot cutters
- Porcupine cutters
- Specific applications and sets
- Profile milling
- Solid carbide
- Drills
- Boring heads
- Arbors and adaptors

Inserts

Face milling cutters



Characteristics:

Positive milling cutter with 45° entering angle. Its strong inserts accept high cutting depths and high feed per teeth. The original fixing system from Canela allows a quick insert assembly and dismantling. All milling cutters starting from diameter 5.

Applications:

This chamfer milling cutter works well on steels, stainless steel, alloyed steels, cast iron and aluminium alloys. This general purpose milling cutter is recommended for manual machines as well as for C.N.C. machines.

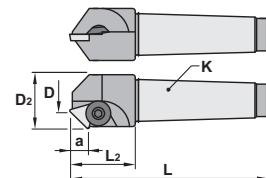
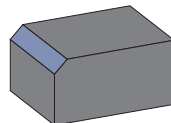
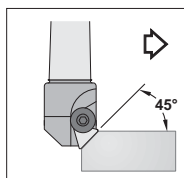

0630.30

Ref.			D	D2	L	L2	a	K	Insert size	
0630.30.005	1		6,5	26,5	125	38	8	MK3	TPUN 1603..	0,350
0630.30.020	3		20,0	40,0	125	38	8	MK3	TPUN 1603..	0,400

Ref.				
0630.30.005		1006	2064	5004
0630.30.020		1006	2064	5004

	TPUN				Positive 11° clearance - Triangular insert.
	Ref.	l	s	d	
	TPUN 1603..	16,50	3,18	9,52	

For more information see page: A.21

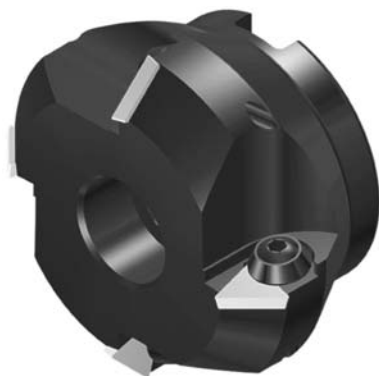

Characteristics:

Positive milling cutter with 45° entering angle. Its strong inserts accept high cutting depths and high feed per teeth. The original fixing system from Canela allows a quick insert assembly and dismantling. All milling cutters starting from diameter 32 are equipped with shim seats to protect the milling cutter body in case of accident.

Applications:

This face chamfer milling cutter works well on steels, stainless steel, alloyed steels, cast iron and aluminium alloys. This general purpose milling cutter is recommended for manual machines as well as for C.N.C. machines.

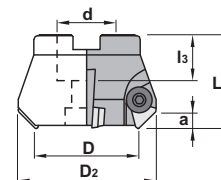
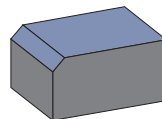
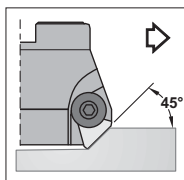

Face milling cutters

Square shoulder cutters

Slot cutters

Porcupine cutters

Specific applications and sets

Profile milling

Solid carbide

Drills

Boring heads

Arbors and adaptors

0630.90 45°

Ref.			D	D ₂	L	d	l ₃	a	Insert size	
0630.90.032	3	32	54	50	22	20	8	TPUN 1603..	0,450	
0630.90.040	3	40	62	50	27	22	8	TPUN 1603..	0,550	
0630.90.050	4	50	72	50	27	22	8	TPUN 1603..	0,800	
0630.90.063	4	63	85	50	32	25	8	TPUN 1603..	1,200	
0630.90.080	5	80	102	50	40	29	8	TPUN 1603..	1,700	

Ref.						
0630.90.032	1006	2064	3016	4016	5004	912,10
0630.90.040	1006	2064	3016	4016	5004	912,12
0630.90.050	1006	2064	3016	4016	5004	912,12
0630.90.063	1006	2064	3016	4016	5004	912,16
0630.90.080	1006	2064	3016	4016	5004	912,20

TPUN		l	s	d	Positive 11° clearance - Triangular inserts
Ref.	TPUN 1603..	16,50	3,18	9,52	
For more information see page: A.21					
TPUN					

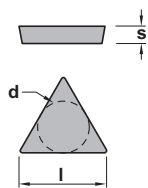

Inserts

Face milling cutters



Characteristics:

Positive milling cutter with 45° entering angle. Its strong inserts accept high cutting depths and high feed per teeth. The original fixing system from Canela allows a quick insert assembly and dismantling. All milling cutters starting from diameter 32 are equipped with shim seats to protect the milling cutter body in case of accident.

Applications:

This face chamfer milling cutter works well on steels, stainless steel, alloyed steels, cast iron and aluminium alloys. This general purpose milling cutter is recommended for manual machines as well as for C.N.C. machines.

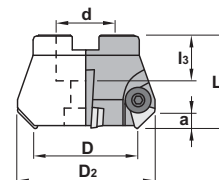
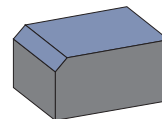
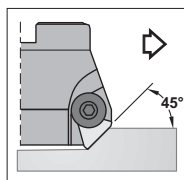

0640.90 45°

Ref.		D	D2	L	d	l3	a	Insert size	
0640.90.032	3	32	62	50	22	20	11	TPUN 2204..	0,450
0640.90.040	3	40	70	50	27	22	11	TPUN 2204..	0,700
0640.90.050	4	50	80	50	27	22	11	TPUN 2204..	0,800
0640.90.063	4	63	93	50	32	25	11	TPUN 2204..	1,300
0640.90.080	5	80	110	50	40	29	11	TPUN 2204..	1,800

Ref.						
0640.90.032	1008	2088	3022	4022	5005	912,10
0640.90.040	1008	2088	3022	4022	5005	912,12
0640.90.050	1008	2088	3022	4022	5005	912,12
0640.90.063	1008	2088	3022	4022	5005	912,16
0640.90.080	1008	2088	3022	4022	5005	912,20

	TPUN			Positive 11° clearance - Triangular inserts
	Ref.	l	s	
	TPUN 2204..	22,00	4,76	12,70
	TPUN			

For more information see page: A.21

0630 / 0640

Positive milling cutter with 45° entering angle. Its strong inserts accept high cutting depths and high feed per teeth. The original fixing system from Canela allows a quick insert assembly and dismantling. All milling cutters starting from diameter 32 are equipped with shim seats to protect the milling cutter body in case of accident. This face chamfer milling cutter works well on steels, stainless steel, alloyed steels, cast iron and aluminium alloys. This general purpose milling cutter is recommended for manual machines as well as for C.N.C. machines.



Face milling cutters

Square shoulder cutters

Slot cutters

Porcupine cutters

Specific applications and sets

Profile milling

Solid carbide

Drills

Boring heads

Arbors and adaptors

Inserts

Face milling cutters



Characteristics:

Chamfering milling cutter for specific operations. The insert is fixed by a Torx screw that allows a good chip evacuation and an easy use. Milling cutter equipped with short cylindrical shank.

Applications:

This chamfering milling cutter works well on steels, alloyed steels, stainless steels and refractors. This general milling cutter for diversified manufacture is recommended for small conventional milling machines and machining centers.

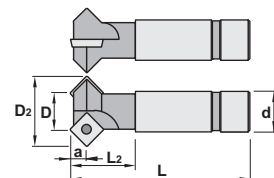
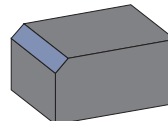
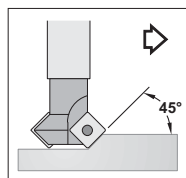

0740.00

Ref.			D	D ₂	L	L ₂	d	a	Insert size	
0740.00.005	1	6,5	22	110	35	20	7	SPM.. 1204..	0,250	
0740.00.020	2	20,0	37	125	35	25	7	SPM.. 1204..	0,450	

Ref.			
0740.00.005		1550	5520
0740.00.020		1550	5520

SPM..		l	s	d	Positive 11° clearance - Square insert.
Ref.	SPM.. 1204..	12,70	4,76	12,70	
For more information see page: A.19					
SPMT	SPMW				



Characteristics:

Chamfering milling cutter for specific operations.
The insert is fixed by a Torx screw that allows a good chip evacuation and an easy use.
Milling cutter equipped with Weldon shank.

Applications:

This chamfering milling cutter works well on steels, alloyed steels, stainless steels and refractors.
This general milling cutter for diversified manufacture is recommended for small conventional milling machines and machining centers.

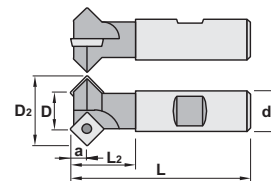
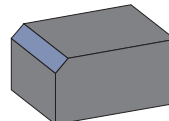
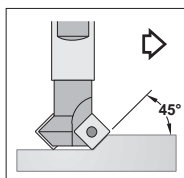

0740.07

Ref.		D	D ₂	L	L ₂	d	a	Insert size	
0740.07.005	1	6,5	22	110	35	25	7	SPM.. 1204..	0,350
0740.07.020	2	20,0	37	110	35	25	7	SPM.. 1204..	0,400

Ref.		
0740.07.005	1550	5520
0740.07.020	1550	5520

SPM..		l	s	d	Positive 11° clearance - Square insert.
Ref.	SPM.. 1204..	12,70	4,76	12,70	
For more information see page: A.19					
SPMT	SPMW				

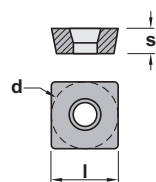

- Face milling cutters
- Square shoulder cutters
- Slot cutters
- Porcupine cutters
- Specific applications and sets
- Profile milling
- Solid carbide
- Drills
- Boring heads
- Arbors and adaptors

Inserts
Face milling cutters



Characteristics:

Chamfering milling cutter for specific operations.
 The insert is fixed by a Torx screw that allows a good chip evacuation and an easy use.
 Milling cutter equipped with Morse shank.

Applications:

This chamfering milling cutter works well on steels, alloyed steels, stainless steels and refractors.
 This general milling cutter for diversified manufacture is recommended for small conventional milling machines and machining centers.

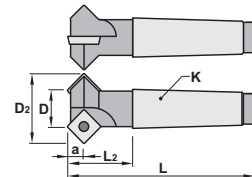
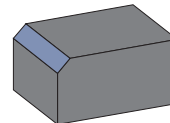
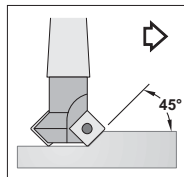

0740.30

Ref.		D	D2	L	L2	a	K	Insert size	
0740.30.005	1	6,5	22	125	39	7	MK3	SPM.. 1204..	0,300
0740.30.020	2	20,0	37	125	39	7	MK3	SPM.. 1204..	0,300

Ref.		
0740.30.005	1550	5520
0740.30.020	1550	5520

SPM..		l	s	d	Positive 11° clearance - Square insert. For more information see page: A.19
Ref.	SPM.. 1204..	12,70	4,76	12,70	



Characteristics:

Positive milling cutter with 45° entering angle that decreases cutting forces and allows a quick feed in a limited capacity machine.

Every insert pocket point to improve the insert life.

The insert thickness is 4,76 mm and is fixed by Torx screws that allow a good chip evacuation.

Applications:

This face chamfering milling cutter works well on steels, stainless steel, alloyed steels, cast iron and aluminium alloys.

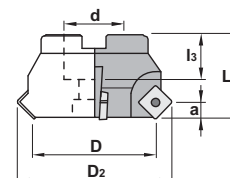
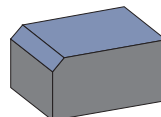
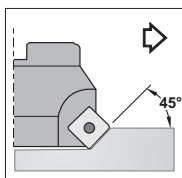

0744.90 45°

Ref.			D	D ₂	L	d	l ₃	a	Insert size	
0744.90.040	4		40	57	40	16	18	7	SC.. 1204..	0,250
0744.90.050	4		50	67	40	22	20	7	SC.. 1204..	0,400
0744.90.063	5		63	80	50	27	22	7	SC.. 1204..	0,850
0744.90.080	6		80	97	50	32	25	7	SC.. 1204..	1,300
0744.90.100	7		100	117	50	40	29	7	SC.. 1204..	2,050
0744.90.125	8		125	142	63	40	30	7	SC.. 1204..	3,250
0744.90.160	9		160	177	63	40	30	7	SC.. 1204..	4,850
0744.90.200	11		200	217	63	60	40	7	SC.. 1204..	8,350

Ref.				
0744.90.040	1250	5620	1058	-
0744.90.050	1250	5620	912,10	-
0744.90.063	1250	5620	912,12	-
0744.90.080	1250	5620	912,16	-
0744.90.100	1250	5620	-	-
0744.90.125	1250	5620	-	-
0744.90.160	1250	5620	912,52	40
0744.90.200	1250	5620	912,56	50

Ref.	SC..	l	s	d	Positive 7° clearance - Square inserts
	SC.. 1204..	12,70	4,76	12,70	
	SCGT-AL	SCMT-39	SCMW		

For more information see page: A.16

- Face milling cutters
- Square shoulder cutters
- Slot cutters
- Porcupine cutters
- Specific applications and sets
- Profile milling
- Solid carbide
- Drills
- Boring heads
- Arbors and adaptors

Inserts

Face milling cutters



Characteristics:

Super positive milling cutter with 45° entering angle that decreases cutting forces and allows a quick feed in a limited capacity machine. The clamps allow a quick insert assembly and dismantling. Every insert pocket is checked point by point to improve the insert file.

These milling cutters are equipped with shim seats, which protect the milling cutter body in case of accident.

Applications:

This milling cutter works well on hard steels, alloyed steels, stainless steels, refractory casts and aluminium alloys.

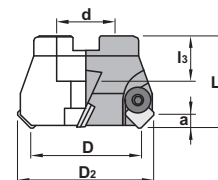
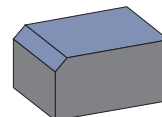
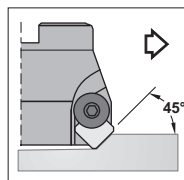

0748.90 45°

Ref.			D	D2	L	d	l3	a	Insert size	
0748.90.050	4	50	63	40	22	20	6	SEK.. 1203..	0,350	
0748.90.063	5	63	76	50	22	20	6	SEK.. 1203..	0,850	
0748.90.080	6	80	93	50	27	22	6	SEK.. 1203..	1,200	
0748.90.100	6	100	113	50	32	25	6	SEK.. 1203..	1,850	
0748.90.125	7	125	138	63	40	30	6	SEK.. 1203..	3,250	
0748.90.160	8	160	173	63	40	30	6	SEK.. 1203..	4,600	
0748.90.200	10	200	213	63	60	30	6	SEK.. 1203..	9,100	

Ref.							
0748.90.050	1006L	2063	3010	4016	5004	912,10	-
0748.90.063	1006L	2063	3010	4012	5004	912,10	-
0748.90.080	1006L	2063	3010	4012	5004	912,12	-
0748.90.100	1006L	2063	3010	4012	5004	912,17	-
0748.90.125	1006L	2063	3010	4012	5004	-	-
0748.90.160	1006L	2063	3010	4012	5004	912,52	40
0748.90.200	1006L	2063	3010	4012	5004	912,56	50

SEK..		l	s	d	Positive 20° clearance - Square inserts
Ref.	SEK.. 1203..	12,70	3,18	12,70	
For more information see page: A.17					
SEKN	SEKR				



Characteristics:

Super positive milling cutter with 45° entering angle that decreases cutting forces and allows a quick feed in a limited capacity machine. The fixing system by wedge ensures an excellent fixation of the insert and a higher security on difficult conditions. The indexable cartridges protect the milling cutter body in case of accident.

Applications:

This milling cutter works well on hard steels, alloyed steels, stainless steels, refractory casts and aluminium alloys.

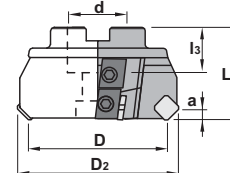
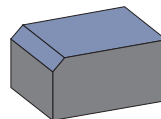
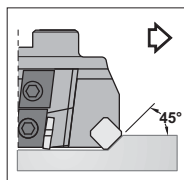

0748.99 45°

Ref.			D	D ₂	L	d	l ₃	a	Insert size	
0748.99.080	6	80	92	50	27	22	6	SEK.. 1203..	1,450	
0748.99.100	8	100	112	50	32	25	6	SEK.. 1203..	2,250	
0748.99.125	8	125	137	63	40	30	6	SEK.. 1203..	3,750	
0748.99.160	10	160	172	63	40	30	6	SEK.. 1203..	5,000	
0748.99.200	12	200	212	63	60	40	6	SEK.. 1203..	7,300	
0748.99.250	16	250	262	63	60	40	6	SEK.. 1203..	12,050	

Ref.									
0748.99.080	1077	5620	6488	6489	6918	1460	912,12	-	
0748.99.100	1077	5620	6488	6489	6918	1460	912,17	-	
0748.99.125	1077	5620	6488	6489	6918	1460	-	-	
0748.99.160	1077	5620	6488	6489	6918	1460	912,52	40	
0748.99.200	1077	5620	6488	6489	6918	1460	912,56	50	
0748.99.250	1077	5620	6488	6489	6918	1460	912,56	50	

SEK..		l	s	d	Positive 20° clearance - Square inserts
Ref.	SEK.. 1203..	12,70	3,18	12,70	
					For more information see page: A.17
	SEKN	SEKR			

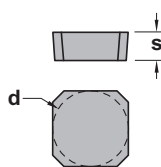

- Face milling cutters
- Square shoulder cutters
- Slot cutters
- Porcupine cutters
- Specific applications and sets
- Profile milling
- Solid carbide
- Drills
- Boring heads
- Arbors and adaptors

Inserts

Face milling cutters



Characteristics:

Super positive milling cutter with 45° entering angle that decreases cutting forces and allows a quick feed in a limited capacity machine. The fixing system by wedge ensures an excellent fixation of the insert and a higher security on difficult conditions. The indexable cartridges protect the milling cutter body in case of accident.

Applications:

This milling cutter works well on hard steels, alloyed steels, stainless steels, refractory casts and aluminium alloys.

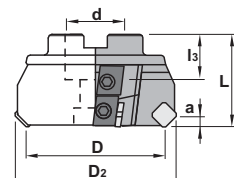
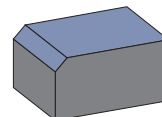
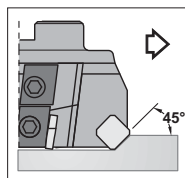

0758.99 45°

Ref.			D	D ₂	L	d	l ₃	a	Insert size	
0758.99.080	6		80	98	50	27	22	9	SEK.. 1504..	1,350
0758.99.100	8		100	118	50	32	25	9	SEK.. 1504..	2,200
0758.99.125	8		125	143	63	40	30	9	SEK.. 1504..	3,550
0758.99.160	10		160	178	63	40	30	9	SEK.. 1504..	5,450
0758.99.200	12		200	218	63	60	40	9	SEK.. 1504..	9,050
0758.99.250	16		250	268	63	60	40	9	SEK.. 1504..	13,250

Ref.									
0758.99.080	1077	5620	6490	6491	6920	1460	912,12	-	-
0758.99.100	1077	5620	6490	6491	6920	1460	912,17	-	-
0758.99.125	1077	5620	6490	6491	6920	1460	-	-	-
0758.99.160	1077	5620	6490	6491	6920	1460	912,52	40	40
0758.99.200	1077	5620	6490	6491	6920	1460	912,56	50	50
0758.99.250	1077	5620	6490	6491	6920	1460	912,56	50	50

SEK..		l	s	d	Positive 20° clearance - Square inserts
Ref.	SEK.. 1504..	15,88	4,76	15,88	
					For more information see page: A.17
	SEKN	SEKR			

0748 / 0758

Super positive milling cutter with 45° entering angle that decreases cutting forces and allows a quick feed in a limited capacity machine. The fixing system by wedge ensures an excellent fixation of the insert and a higher security on difficult conditions. The indexable cartridges protect the milling cutter body in case of accident. This milling cutter works well on hard steels, alloyed steels, stainless steels, refractory casts and aluminium alloys. The axial regulation screw allows a perfect adjustment for super-finishing applications.

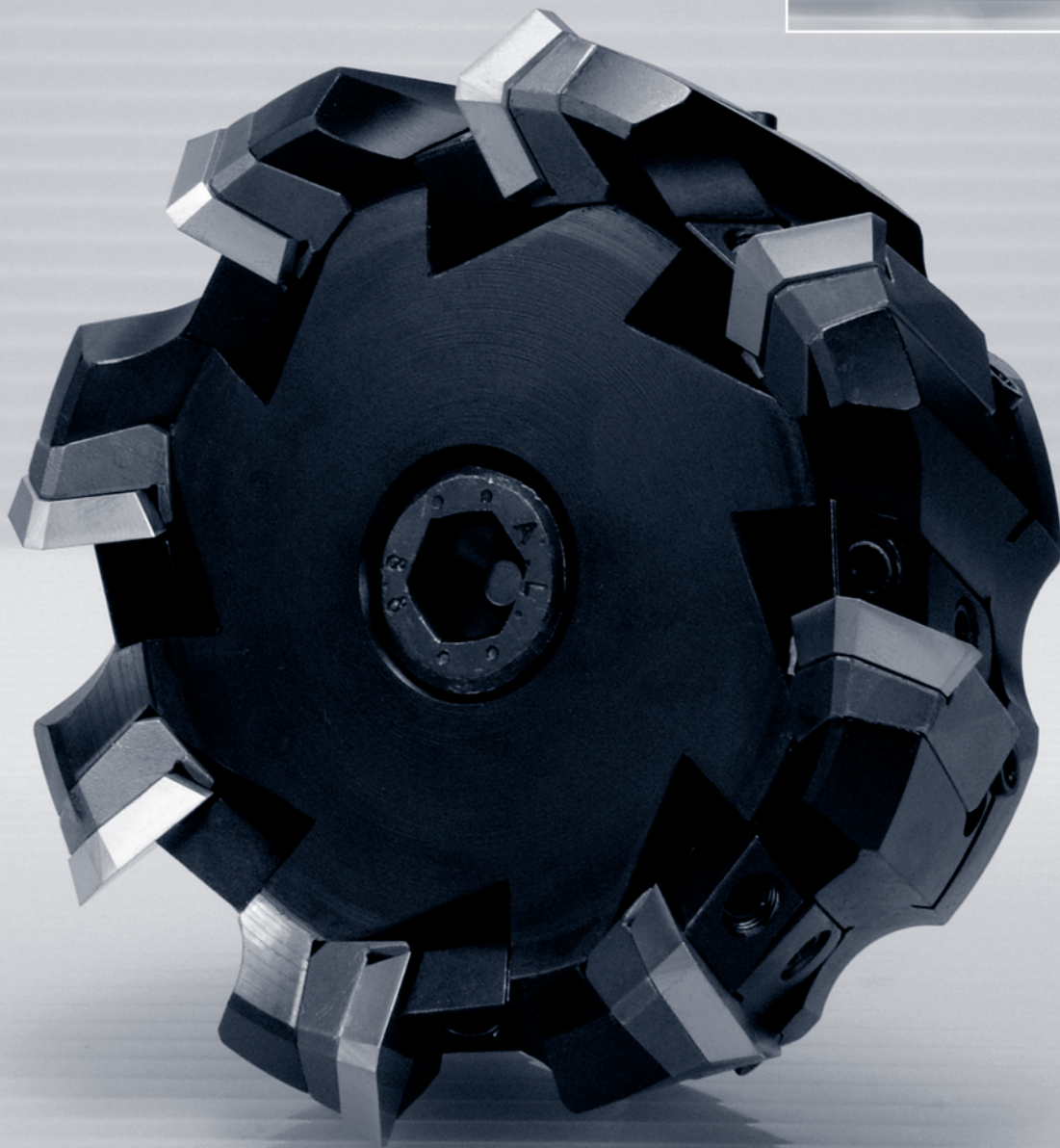
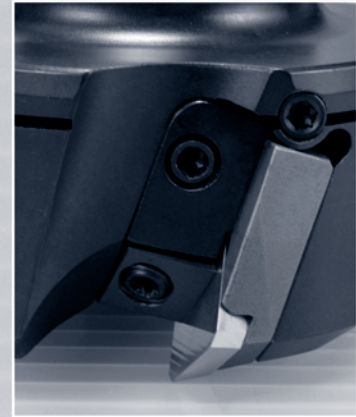

Face milling cutters

Square shoulder cutters

Slot cutters

Porcupine cutters

Specific applications and sets

Profile milling

Solid carbide

Drills

Boring heads

Arbors and adaptors

Inserts

Face milling cutters



Characteristics:

Positive milling cutter with 75° entering angle. Its strong inserts accept high feed per teeth. Its screw fixing allows a fast and clean assembly and dismantling of the inserts.

Applications:

This face milling cutter works well on steels, stainless steel, alloyed steels, cast iron and aluminium alloys. This milling cutter, recommended for manual machines as well as for C.N.C machines, is made in order to use the edges of APMT and APKT inserts that are not used currently.

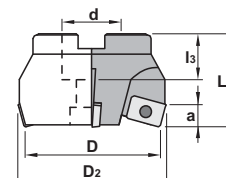
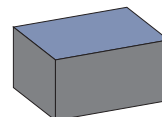
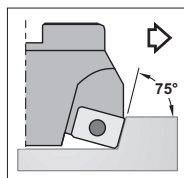

1430.90 75°

Ref.			D	D ₂	L	d	l ₃	a	Insert size	
1430.90.050	3		50	54	40	16	22	7	AP.. 1604..	0,350
1430.90.063	4		63	67	50	27	25	7	AP.. 1604..	0,700
1430.90.080	5		80	84	50	32	25	7	AP.. 1604..	1,100
1430.90.100	6		100	104	50	40	29	7	AP.. 1604..	1,900

Ref.				
1430.90.050	1240		5615	1058
1430.90.063	1240		5615	912,12
1430.90.080	1240		5615	912,17
1430.90.100	1240		5615	912,20

	AP..			Positive 11° clearance - Rectangular inserts.		
	Ref.	l	s	d		
	AP.. 1604..	17,00	4,76	9,52		
	APFT	APHT-AL	APKT	APKT-26	APMT	APMT-26

For more information see page: A.10

1430.90

Positive milling cutter with 75° entering angle. Its strong inserts accept high feed per teeth. Its screw fixing allows a fast and clean assembly and dismantling of the inserts. This face milling cutter works well on steels, stainless steel, alloyed steels, cast iron and aluminium alloys. This milling cutter, recommended for manual machines as well as for C.N.C. machines, is made in order to use the edges of APMT and APKT inserts that are not used currently.

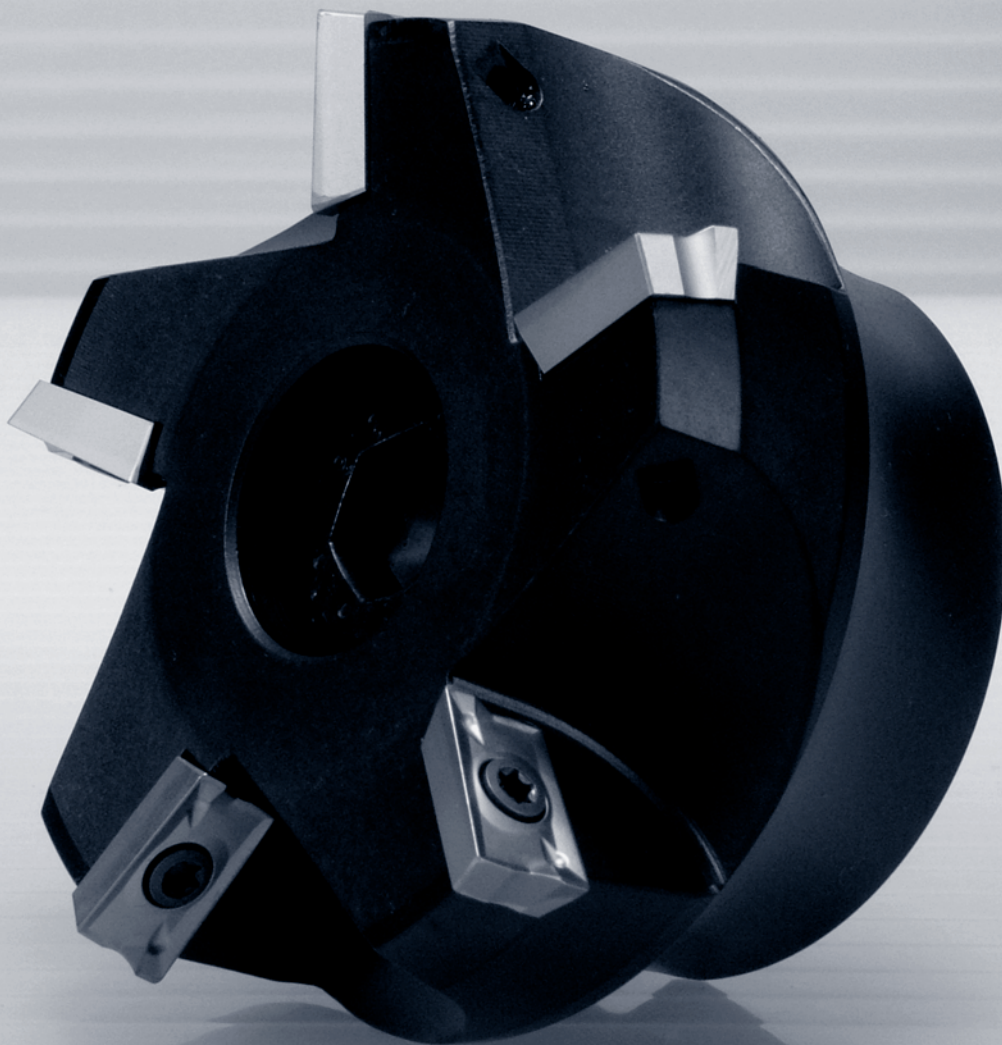
Face milling
cuttersSquare shoulder
cutters

Slot cutters

Porcupine cutters

Specific applications
and sets

Profile milling

Solid carbide

Drills

Boring heads

Arbors and
adaptors

Inserts

Face milling cutters



Characteristics:

Super positive milling cutter with 45° entering angle that decreases cutting forces and allows a quick feed in a limited capacity machine.

Every insert pocket is checked point by point to improve the insert life.

The insert thickness is 4,76 mm and Torx screws allow a good chip evacuation.

Applications:

This face milling cutter works well on steels, stainless steel, alloyed steels, cast iron and aluminium alloys.

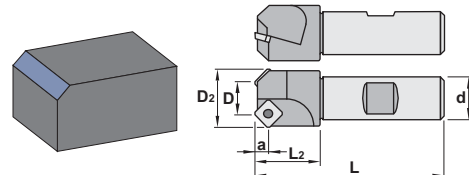
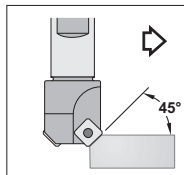

1748.07

Ref.		D	D2	L	L2	d	a	Insert size	
1748.07.032	2	32	44	125	40	32	6	SEH.. 1204..	0,800
1748.07.040	3	40	52	125	40	32	6	SEH.. 1204..	0,900

Ref.		
1748.07.032	1550	5520
1748.07.040	1550	5520

	SEH..			Positive 20° clearance - Square insert.
	Ref.	l	s	
	SEH.. 1204..	12,70	4,76	
	SEHT	SEHT-AL	SEHW	

For more information see page: A.17



Characteristics:

Super positive milling cutter with 45° entering angle that decreases cutting forces and allows a quick feed in a limited capacity machine.

Every insert pocket is checked point by point to improve the insert life.

The insert thickness is 4,76 mm and Torx screws allow a good chip evacuation.

Applications:

This face milling cutter works well on steels, stainless steel, alloyed steels, cast iron and aluminium alloys.

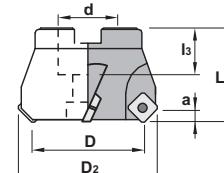
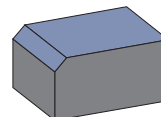
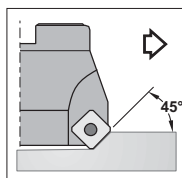

1748.90 45°

Ref.			D	D ₂	L	d	l ₃	a	Insert size	
1748.90.050	4		50	62	40	22	20	6	SEH.. 1204..	0,350
1748.90.063	5		63	75	50	22	20	6	SEH.. 1204..	0,800
1748.90.080	6		80	92	50	27	22	6	SEH.. 1204..	1,150
1748.90.100	6		100	112	50	32	26	6	SEH.. 1204..	1,700
1748.90.125	7		125	132	63	40	29	6	SEH.. 1204..	2,750
1748.90.160	8		160	172	63	40	29	6	SEH.. 1204..	4,600
1748.90.200	10		200	212	63	60	40	6	SEH.. 1204..	6,600

Ref.				
1748.90.050	1550	5620	912,10	-
1748.90.063	1550	5620	912,10	-
1748.90.080	1550	5620	912,12	-
1748.90.100	1550	5620	912,17	-
1748.90.125	1550	5620	-	-
1748.90.160	1550	5620	912,52	40
1748.90.200	1550	5620	912,56	50

SEH..		l	s	d	Positive 20° clearance - Square inserts.
Ref.	SEH.. 1204..	12,70	4,76	12,70	
					For more information see page: A.17
					SEHT

Face milling cutters
Square shoulder cutters
Slot cutters
Porcupine cutters
Specific applications and sets
Profile milling
Solid carbide
Drills
Boring heads
Arbors and adaptors

Inserts

Face milling cutters



Characteristics:

Super positive milling cutter with 45° entering angle that decreases cutting forces and allows a quick feed in a limited capacity machine.

Every insert pocket is checked point by point to improve the insert life.

The insert thickness is 4,76 mm and Torx screws allow a good chip evacuation.

Applications:

This face milling cutter works well on steels, stainless steel, alloyed steels, cast iron and aluminium alloys.

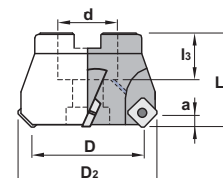
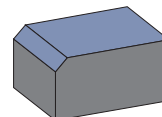
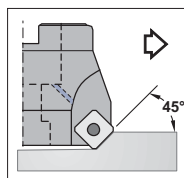

1748.93 45°



Internal coolant system

Ref.			D	D ₂	L	d	l ₃	a	Insert size	
1748.93.050	4		50	62	40	22	20	6	SEH.. 1204..	0,350
1748.93.063	5		63	75	50	22	20	6	SEH.. 1204..	0,800
1748.93.080	6		80	92	50	27	22	6	SEH.. 1204..	1,150
1748.93.100	6		100	112	50	32	26	6	SEH.. 1204..	1,700
1748.93.125	7		125	132	63	40	29	6	SEH.. 1204..	2,750

Ref.			
1748.93.050	1550	5620	912,10
1748.93.063	1550	5620	912,10
1748.93.080	1550	5620	912,12
1748.93.100	1550	5620	912,17
1748.93.125	1550	5620	-

	SEH..			Positive 20° clearance - Square inserts.
	Ref.	l	s	
	SEH.. 1204..	12,70	4,76	12,70
	SEHT	SEHT-AL	SEHW	

For more information see page: A.17



Characteristics:

Super positive milling cutter with 45° entering angle that decreases cutting forces and allows a quick feed in a limited capacity machine. Every insert pocket is checked point by point to improve the insert life. The indexable cartridges protect the milling cutter body in case of accident.

Applications:

This face milling cutter works well on steels, stainless steel, alloyed steels, cast iron and aluminium alloys.

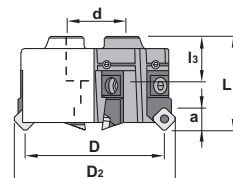
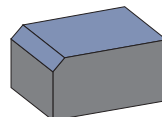
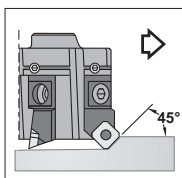

1748.99 45°

Ref.			D	L	d	l3	a	Insert size	
1748.99.160	10	160	63	40	30	6	SEH.. 1204..	5,450	
1748.99.200	12	200	63	60	40	6	SEH.. 1204..	9,000	
1748.99.250	16	250	63	60	40	6	SEH.. 1204..	14,250	
1748.99.315	20	315	63	60	40	6	SEH.. 1204..	31,000	
1748.99.400	22	400	63	60	40	6	SEH.. 1204..	47,500	
1748.99.500	28	500	63	60	40	6	SEH.. 1204..	85,000	

Ref.						
1748.99.160	1550	5620	6748	1788	1460	40
1748.99.200	1550	5620	6748	1788	1460	50
1748.99.250	1550	5620	6748	1788	1460	50
1748.99.315	1550	5620	6748	1788	1460	50/60
1748.99.400	1550	5620	6748	1788	1460	50/60
1748.99.500	1550	5620	6748	1788	1460	50/60

Ref.	SEH..			Positive 20° clearance - Square inserts.
	l	s	d	
SEH.. 1204..	12,70	4,76	12,70	
	SEHT	SEHT-AL	SEHW	

For more information see page: A.17

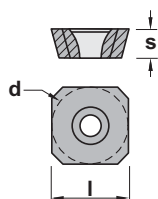

- Face milling cutters
- Square shoulder cutters
- Slot cutters
- Porcupine cutters
- Specific applications and sets
- Profile milling
- Solid carbide
- Drills
- Boring heads
- Arbors and adaptors

Inserts

Face milling cutters

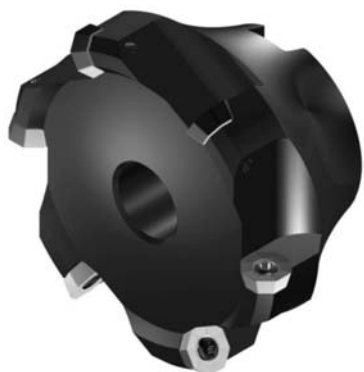

Characteristics:

Multipurpose milling cutter with 42° entering angle that decreases cutting forces and allows a quick feed in a limited capacity machine.

Every insert pocket is checked point by point to improve the insert life.

The insert thickness is 4,76 mm and Torx screws allow a good chip evacuation.

Applications:

This face milling cutter works well on steels, stainless steel, alloyed steels, cast iron and aluminium alloys.

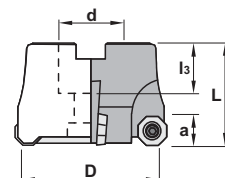
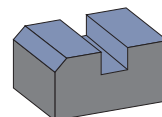
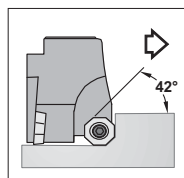

1845.90 42°

Ref.			D	L	d	l ₃	a	Insert size	
1845.90.040	4		40	40	16	20	5	ODM.. 0404..	0,250
1845.90.050	4		50	40	22	22	5	ODM.. 0404..	0,350
1845.90.063	5		63	50	27	25	5	ODM.. 0404..	0,700
1845.90.080	6		80	50	32	26	5	ODM.. 0404..	1,200
1845.90.100	7		100	50	40	29	5	ODM.. 0404..	1,850
1845.90.125	7		125	63	40	29	5	ODM.. 0404..	3,550
1845.90.160	8		160	63	40	29	5	ODM.. 0404..	4,700
1845.90.200	10		200	63	60	40	5	ODM.. 0404..	8,200

Ref.				
1845.90.040	1245	5615	1058	-
1845.90.050	1245	5615	912,10	-
1845.90.063	1245	5615	912,12	-
1845.90.080	1245	5615	912,16	-
1845.90.100	1245	5615	912,20	-
1845.90.125	1245	5615	-	-
1845.90.160	1245	5615	912,52	40
1845.90.200	1245	5615	912,56	50

		ODM..			Positive 15° clearance - Octagonal inserts.		
Ref.	ODM.. 0404..	l	s	d			
		4,00	4,76	12,70			
					For more information see page: A.14		
		ODMT	ODMW				



Characteristics:

Multipurpose milling cutter with 42° entering angle that decreases cutting forces and allows a quick feed in a limited capacity machine. Every insert pocket is checked point by point to improve the insert life. The indexable cartridges protect the milling cutter body in case of accident.

The insert thickness is 4,76 mm and Torx screws allow a good chip evacuation.

Applications:

This face milling cutter works well on steels, stainless steel, alloyed steels, cast iron and aluminium alloys.

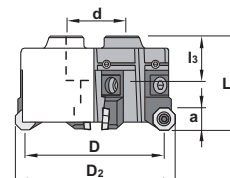
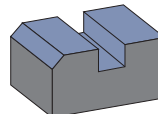
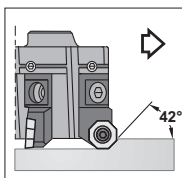

1845.99 42°

Ref.			D	L	d	l3	a	Insert size	
1845.99.160	10	160	63	40	30	5	ODM.. 0404..	5,450	
1845.99.200	12	200	63	60	40	5	ODM.. 0404..	9,000	
1845.99.250	16	250	63	60	40	5	ODM.. 0404..	14,250	
1845.99.315	20	315	63	60	40	5	ODM.. 0404..	31,000	
1845.99.400	22	400	63	60	40	5	ODM.. 0404..	47,500	
1845.99.500	28	500	63	60	40	5	ODM.. 0404..	85,000	

Ref.						
1845.99.160	1245	5615	6845	1788	1460	40
1845.99.200	1245	5615	6845	1788	1460	50
1845.99.250	1245	5615	6845	1788	1460	50
1845.99.315	1245	5615	6845	1788	1460	50/60
1845.99.400	1245	5615	6845	1788	1460	50/60
1845.99.500	1245	5615	6845	1788	1460	50/60

ODM..		l	s	d	Positive 15° clearance - Octogonal inserts.
Ref.	ODM.. 0404..	4,00	4,76	12,70	
For more information see page: A.14					

- Face milling cutters
- Square shoulder cutters
- Slot cutters
- Porcupine cutters
- Specific applications and sets
- Profile milling
- Solid carbide
- Drills
- Boring heads
- Arbors and adaptors

Inserts

Face milling cutters

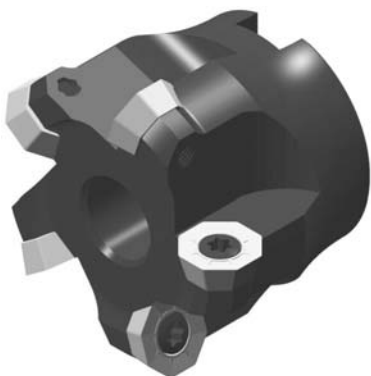

Characteristics:

Multipurpose milling cutter with 42° entering angle that decreases cutting forces and allows a quick feed in a limited capacity machine.

Every insert pocket is checked point by point to improve the insert life.

The insert thickness is 5,55 mm and Torx screws allow a good chip evacuation.

Applications:

This face milling cutter works well on steels, stainless steel, alloyed steels, cast iron and aluminium alloys.

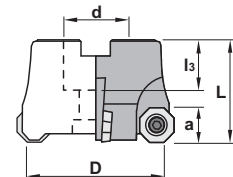
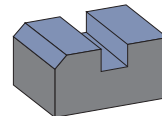
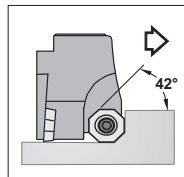

1855.90 42°

Ref.		D	L	d	l ₃	a	Insert size	
1855.90.063	5	63	50	27	25	8	ODM.. 0605..	0,850
1855.90.080	6	80	50	32	26	8	ODM.. 0605..	1,200
1855.90.100	7	100	50	40	29	8	ODM.. 0605..	1,850
1855.90.125	8	125	63	40	29	8	ODM.. 0605..	3,250
1855.90.160	10	160	63	40	29	8	ODM.. 0605..	4,600
1855.90.200	12	200	63	60	40	8	ODM.. 0605..	9,100

Ref.				
1855.90.063	1250	5620	912,12	-
1855.90.080	1250	5620	912,16	-
1855.90.100	1250	5620	-	-
1855.90.125	1250	5620	-	-
1855.90.160	1250	5620	912,52	40
1855.90.200	1250	5620	912,56	50

ODM..		l	s	d	Positive 15° clearance - Octagonal inserts.
Ref.	ODM.. 0605..	6,00	5,55	16,00	
For more information see page: A.14					



Characteristics:

Multipurpose milling cutter with 42° entering angle that decreases cutting forces and allows a quick feed in a limited capacity machine. Every insert pocket is checked point by point to improve the insert life. The indexable cartridges protect the milling cutter body in case of accident.

The insert thickness is 5,55 mm and Torx screws allow a good chip evacuation.

Applications:

This face milling cutter works well on steels, stainless steel, alloyed steels, cast iron and aluminium alloys.

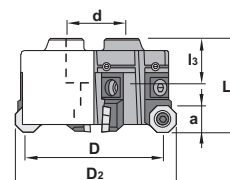
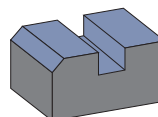
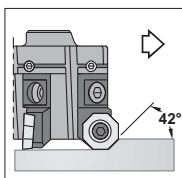

1855.99 42°

Ref.			D	L	d	l3	a	Insert size	
1855.99.160	10	160	63	40	30	8	ODM.. 0605..	5,000	
1855.99.200	12	200	63	60	40	8	ODM.. 0605..	7,300	
1855.99.250	16	250	63	60	40	8	ODM.. 0605..	12,050	
1855.99.315	20	315	63	60	40	8	ODM.. 0605..	31,000	
1855.99.400	22	400	63	60	40	8	ODM.. 0605..	47,500	
1855.99.500	28	500	63	60	40	8	ODM.. 0605..	85,000	

Ref.						
1855.99.160	1550	5620	6846	1788	1460	40
1855.99.200	1550	5620	6846	1788	1460	50
1855.99.250	1550	5620	6846	1788	1460	50
1855.99.315	1550	5620	6846	1788	1460	50/60
1855.99.400	1550	5620	6846	1788	1460	50/60
1855.99.500	1550	5620	6846	1788	1460	50/60

ODM..		l	s	d	Positive 15° clearance - Octogonal inserts.
Ref.	ODM.. 0605..	6,00	5,55	16,00	
For more information see page: A.14					

- Face milling cutters
- Square shoulder cutters
- Slot cutters
- Porcupine cutters
- Specific applications and sets
- Profile milling
- Solid carbide
- Drills
- Boring heads
- Arbors and adaptors

1845 / 1855

Multipurpose milling cutter with 42° entering angle that decreases cutting forces and allows a quick feed in a limited capacity machine.

Every insert pocket is checked point by point to improve the insert life.

The insert thickness is 4,76 mm and Torx screws allow a good chip evacuation.

This face milling cutter works well on steels, stainless steel, alloyed steels, cast iron and aluminium alloys.

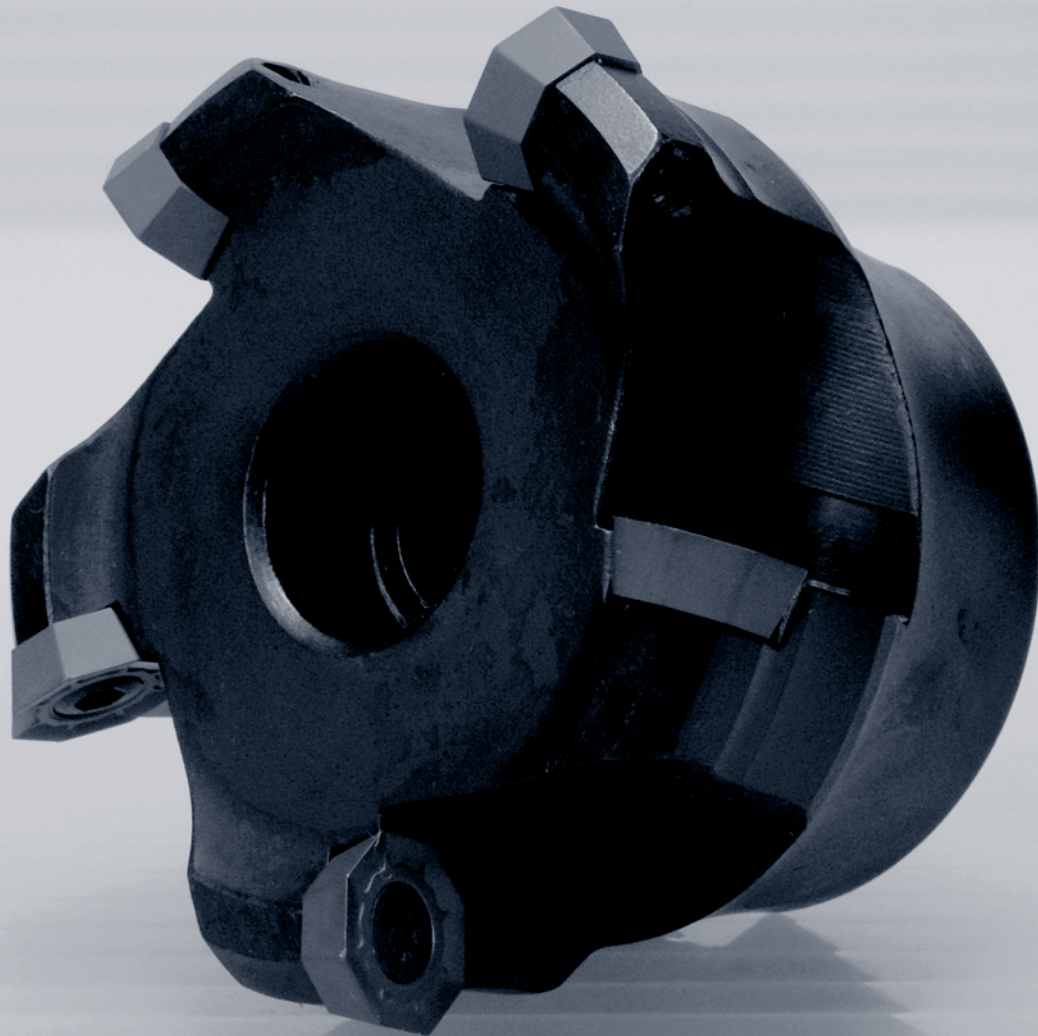

Cutting data for face milling cutters

Material	P	HB	Condition	Cutting speed m/min.			
				TIN25	TIN41	PM25	PM40
				0.3-0.2-0.1	0.3-0.2-0.1	0.4-0.2-0.1	0.4-0.2-0.1
Unalloyed steel	110 150 310	C<0.25% C<0.80% C<1.40%	250-300-390	250-350-450	180-250-310	100-130-160	
			155-180-255	100-120-165	120-145-205	65-85-100	
			135-165-210	75-110-135	95-130-170	50-75-85	
Low alloyed steel	125-225 220-450	Hardened	170-200-250 110-130-150	100-120-165 55-75-95	120-160-200 70-100-120	95-85-105 40-55-65	
High alloyed steel	150-250 250-300	Hardened	170-200-250 110-130-150	90-115-150 60-75-90	110-140-180 65-90-120	60-80-90 40-50-60	
High alloyed steel	150-250 250-350	Rapid steel (HSS) Hardened Hardened tool steel	130-160-195	75-105-130	90-125-155 70-95-120	50-60-75 30-40-50	
Stainless steel	150-270	Ferritic, Martensitic	155-180-250	110-150-190	120-165-210	80-105-130	
Steel castings	150 150-250 160-200	Unalloyed Low alloyed High alloyed	140-180-250 125-150-190 90-110-130	80-120-150 70-100-120 55-70-80	100-145-180 90-120-150 65-90-100	60-75-95 50-65-80 35-45-55	
Stainless steel castings	150-250	Ferritic, martensitic		50-80	50-70-80	30-40-50	

Material	M	HB	Condition	Cutting speed m/min.			
				TIN25	TIN41	KM15	PM25
				0.4-0.2-0.1	0.3-0.2-0.1	0.2-0.1	0.4-0.2-0.1
Stainless steel annealed	150-220	Austenitic	180-220-280	80-150-220		150-240-300	
Steel castings	200	Stainless, austenitic		40-70		50-60	
Iron, nickel and cobalt base castings	180-300 220-300 220-300			40-100	20-40 20-40 10-20		
Titanium alloys	300-400						

Material	K	HB	Condition	Cutting speed m/min.			
				TIN25	TIN41	KM15	PM25
				0.4-0.2-0.1	0.3-0.2-0.1	0.2-0.1	0.4-0.2-0.1
Tempered steel	HCR 50-65					15-20-30	
Stainless steel castings	250	Manganese steel 12-14% Mn			12-18-20		
Malleable cast iron	110-145 200-230	Short chipping Long chipping		200-300 150-200	65-80-95 50-65-80	100-125-150 90-115-135	
Grey cast iron	180 260	Low tensile strength High tensile strength		200-400 150-350	70-95-120 50-70-90	85-120-155 70-90-115	
Nodular cast iron	160 250	Ferritic Pearlitic	100-130 90-110	100-250 100-180	50-65-80 45-60-70	70-90-115 65-80-100	
Chilled cast iron	HCR 40-60						
Aluminium alloys	60-100 75-110	Non cast Cast			500-2100 400-2000		
Aluminium with high contents of Si		10-14% Si 14-16% Si 16-18% Si			200-1000 110-200		

Face milling cutters

Square shoulder cutters

Slot cutters

Porcupine cutters

Specific applications and sets

Profile milling

Solid carbide

Drills

Boring heads

Arbors and adaptors